

8-M3\*6 (Suggest screw size)

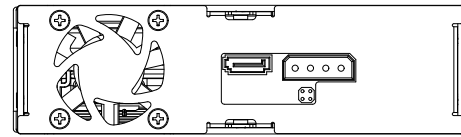
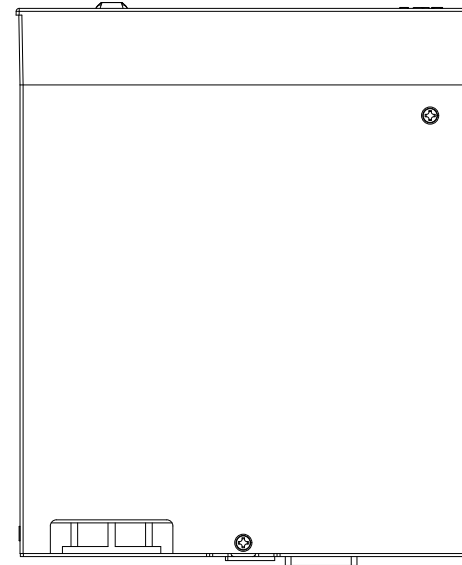
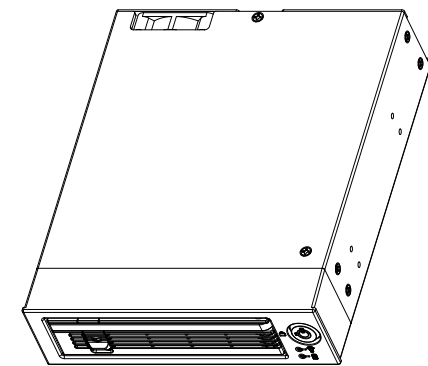
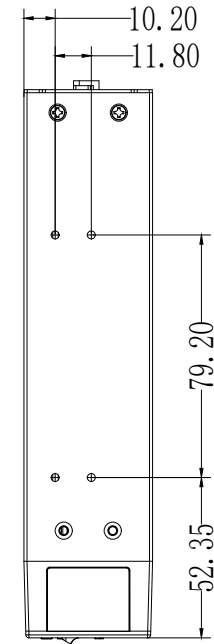
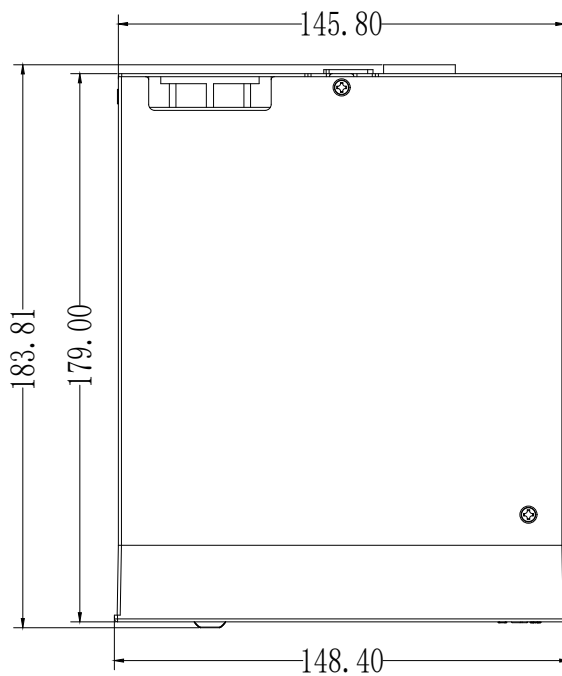
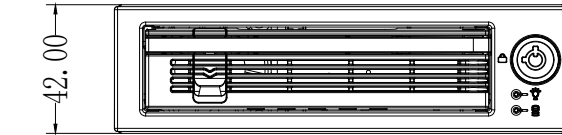
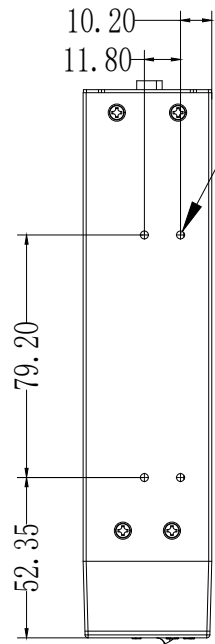

APPLIED MODEL

CREMAX TECH CO., LTD.

TITLE		MATERIAL		TOLERANCE	
MB876SK-B 全组立图				10mm以下 ±0.1 10-50mm ±0.15 50mm以上 ±0.2 X° ±0.5°	
DRAWN	DATE	FINISHED		SCALE	
	2022/9/15			1:1	
CHECHED	DATE	PART NO.	UNIT	REV.	
			mm		
APPROVED	DATE	DWG. NO.	SHEET 1 OF 1		